



EN Operating instructions.pages 1 to 6
Translation of the original operating instructions

Content

1 About this document

1.1 Function 1

1.2 Target group: authorised qualified personnel. 1

1.3 Explanation of the symbols used 1

1.4 Appropriate use 1

1.5 General safety instructions 1

1.6 Warning about misuse 1

1.7 Exclusion of liability 2

2 Product description

2.1 Ordering code 2

2.2 Special versions. 2

2.3 Destination and use 2

2.4 Technical data 2

2.5 Safety classification 2

3 Mounting

3.1 General mounting instructions 3

3.2 Dimensions 3

4 Electrical connection

4.1 General information for electrical connection. 4

4.2 Contact variants. 4

4.3 Switch travel. 4

5 Set-up and maintenance

5.1 Functional testing. 5

5.2 Maintenance 5

6 Disassembly and disposal

6.1 Disassembly. 5

6.2 Disposal. 5

7 Appendix

7.1 EC Declaration of conformity 6

1. About this document

1.1 Function

This operating instructions manual provides all the information you need for the mounting, set-up and commissioning to ensure the safe operation and disassembly of the safety switchgear. The operating instructions must be available in a legible condition and a complete version in the vicinity of the device.

1.2 Target group: authorised qualified personnel

All operations described in this operating instructions manual must be carried out by trained specialist personnel, authorised by the plant operator only.

Please make sure that you have read and understood these operating instructions and that you know all applicable legislations regarding occupational safety and accident prevention prior to installation and putting the component into operation.

The machine builder must carefully select the harmonised standards to be complied with as well as other technical specifications for the selection, mounting and integration of the components.

1.3 Explanation of the symbols used



Information, hint, note:
This symbol is used for identifying useful additional information.



Caution: Failure to comply with this warning notice could lead to failures or malfunctions.
Warning: Failure to comply with this warning notice could lead to physical injury and/or damage to the machine.

1.4 Appropriate use

The products described in these operating instructions are developed to execute safety-related functions as part of an entire plant or machine. It is the responsibility of the manufacturer of a machine or plant to ensure the correct functionality of the entire machine or plant.

The safety switchgear must be exclusively used in accordance with the versions listed below or for the applications authorised by the manufacturer. Detailed information regarding the range of applications can be found in the chapter "Product description".

1.5 General safety instructions

The user must observe the safety instructions in this operating instructions manual, the country-specific installation standards as well as all prevailing safety regulations and accident prevention rules.



Further technical information can be found in the Schmersal catalogues or in the online catalogue on the Internet: www.schmersal.net.

The information contained in this operating instructions manual is provided without liability and is subject to technical modifications.

There are no residual risks, provided that the safety instructions as well as the instructions regarding mounting, commissioning, operation and maintenance are observed.

1.6 Warning about misuse



In case of improper use or manipulation of the safety switchgear, personal hazards or damages to machinery or plant components cannot be excluded when safety switchgear is used. The relevant requirements of the standard ISO 14119 must be observed.

1.7 Exclusion of liability

We shall accept no liability for damages and malfunctions resulting from defective mounting or failure to comply with this operating instructions manual. The manufacturer shall accept no liability for damages resulting from the use of unauthorised spare parts or accessories.

For safety reasons, invasive work on the device as well as arbitrary repairs, conversions and modifications to the device are strictly forbidden; the manufacturer shall accept no liability for damages resulting from such invasive work, arbitrary repairs, conversions and/or modifications to the device.

2. Product description

2.1 Ordering code

This operating instructions manual applies to the following types:

T1C 23②-③Z-④-⑤

No.	Option	Description
①	3	Left-hand model
	4	Swing-door model
	5	Right-hand model
②	5	Metal enclosure
	6	Thermoplastic enclosure
③	01	1 NC contacts
	02	2 NC contacts
	11	1 NO contacts / 1 NC contacts
④	ST	Cable entry M20
	2310	M12 connector (A coding) (B coding)
⑤		Actuator 78 mm
	2313	Prolonged actuator 113 mm



Only if the information described in this operating instructions manual are realised correctly, the safety function and therefore the compliance with the Machinery Directive is maintained.

2.2 Special versions

For special versions, which are not listed in the order code below 2.1, these specifications apply accordingly, provided that they correspond to the standard version.

2.3 Destination and use

The position switches with safety function (Type 1 according to ISO 14119) are suitable for hinged guards, which need to be closed in order to ensure the required operational safety.



The user must evaluate and design the safety chain in accordance with the relevant standards and the required safety level.



The entire concept of the control system, in which the safety component is integrated, must be validated to the relevant standards.

2.4 Technical data

Standards:	IEC 60947-5-1; ISO 13849-1
Design:	EN 50047
Enclosure:	
- 235:	zinc die-cast, enamel finish
- 236:	glass-fibre reinforced thermoplastic, self-extinguishing
Protection class:	IP67
Contact material:	Silver
Contact type:	change-over contact with double break, type Zb or 1 NC or 2 NC contacts, with galvanically separated contact bridges
Switching system:	⊖ IEC 60947-5-1; slow action, NC contact with positive break
Connection:	Screw connection or connector M12
Cable section:	solid and stranded wire; min. 0.75 mm ² ; max. 2.5 mm ² ; incl. conductor ferrules
Cable entry:	M20 x 1.5
Ambient temperature:	-30 °C ... +80 °C
Mechanical life:	> 1 million operations
Positive break angle:	12.5°
Positive break torque:	0.185 Nm
Max. switching frequency:	5000/h
Max. Actuating speed:	1 m/s
Electrical data:	
Utilisation category:	AC-15, DC-13
Rated operating current/voltage I _e /U _e :	4 A / 230 VAC 1 A / 24 VDC
- Connector:	4 A / 50 V
Rated impulse withstand voltage U _{imp} :	6 kV
- Connector:	0.8 kV
Rated insulation voltage U _i :	500 V
- Connector:	50 V
Thermal test current I _{the} :	10 A
Required short-circuit current:	1000 A
Max. fuse rating:	6 A gG D-fuse

2.5 Safety classification

Standards:	ISO 13849-1
Envisaged structure:	
- Basically:	applicable up to Cat. 1 / PL c
- With 2-channel usage and fault exclusion mechanism*:	applicable up to Cat. 3 / PL d with suitable logic unit
B _{10d} (NC contact):	20,000,000
B _{10d} (NO contact) at 10% ohmic contact load:	1,000,000
Service life:	20 years

* If a fault exclusion to the 1-channel mechanics is authorised.

$$MTTF_d = \frac{B_{10d}}{0,1 \times n_{op}} \quad n_{op} = \frac{d_{op} \times h_{op} \times 3600 \text{ s/h}}{t_{cycle}}$$

(Determined values can vary depending on the application-specific parameters h_{op}, d_{op} and t_{cycle} as well as the load.)

If multiple safety components are wired in series, the Performance Level to ISO 13849-1 will be reduced due to the restricted error detection under certain circumstances.

3. Mounting

3.1 General mounting instructions

The mounting dimensions are mentioned at the rear of the enclosure. The fixing screws must be protected against unauthorised tampering. The switch must be installed so that the axis of the lever is as close as possible to the axis of the safety guard. No axial forces may be exercised on the lever. The lever must be connected to the safety guard so that the actuating pin of the lever cannot be brought outside of the engagement (e.g. rivet head or similar). To ensure a proper functioning, the switch must be installed so that the required switch travel is obtained. For safety functions, at least the positive break travel indicated in the switch travel diagram must be obtained. All components have sufficient after-travel to compensate for inaccuracies in the guidance of the actuating system. The actuation of the switch beyond its end stop however must be avoided.

The actuating head can be repositioned by $4 \times 90^\circ$. Unscrew the four screws of the actuating head, reposition the actuating head in the desired position and retighten the four screws.



Please observe the remarks of the standards ISO 12100, EN 953 and ISO 14119.

3.2 Dimensions

All measurements in mm.

T.C 235 / T.C 236

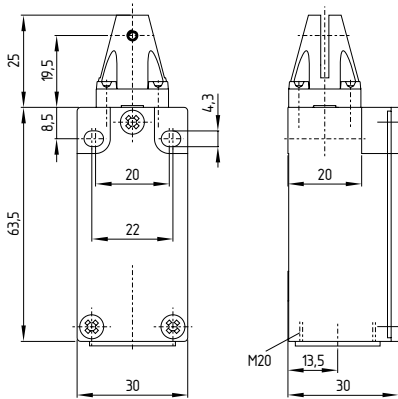

Left-hand model

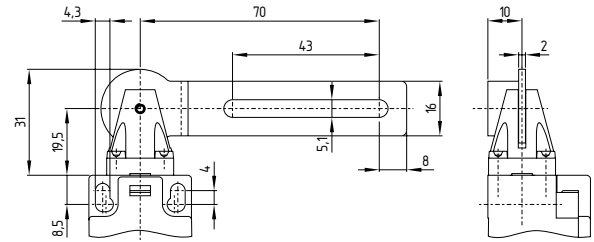

Right-hand model

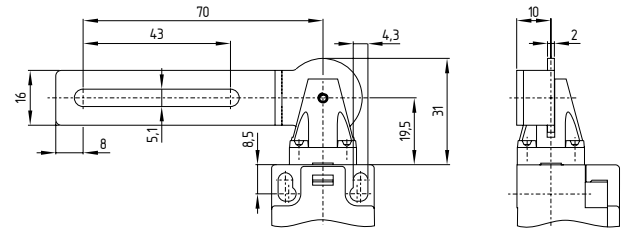

Swing-door model

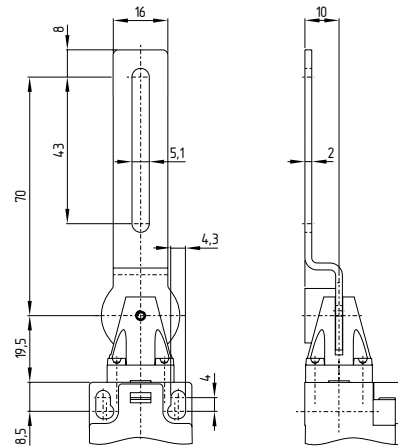

4. Electrical connection

4.1 General information for electrical connection



The electrical connection may only be carried out by authorised personnel in a de-energised condition.

The contact labelling can be found in the wiring compartment of the switch. For the cable entry, suitable cable glands with an appropriate degree of protection must be used. After wiring, dust and soiling must be removed from the wiring compartment. The safety switches with thermoplastic enclosure of the 236 series are double-insulated. The use of a protective ground connector therefore is not authorised.



According to IEC 60204-1, the versions with connector must only be used in PELV circuits.

236: opening the cover



4.2 Contact variants

Contacts are shown with safety guard closed.

T.C 235-02Z
T.C 236-02Z

2 NC

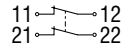

T.C 235-11Z
T.C 236-11Z

1 NO contacts / 1 NC contacts

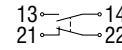

T.C 235-01Z
T.C 236-01Z

1 NC

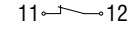

with connector

T.C 235-02Z-ST
T.C 236-02Z-ST

2 NC

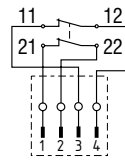

T.C 235-11Z-ST
T.C 236-11Z-ST

1 NO contacts / 1 NC contacts

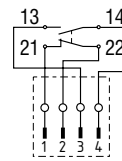

4.3 Switch travel

Switch travel/
Contacts

Left-hand model

Swing-door model

Right-hand model

2 NC

T3C 235-02Z
T3C 236-02Z

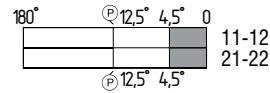

T4C 235-02Z
T4C 236-02Z

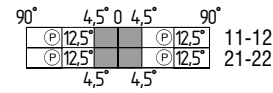

T5C 235-02Z
T5C 236-02Z

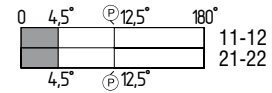

1 NO contacts /
1 NC contacts

T3C 235-11Z
T3C 236-11Z

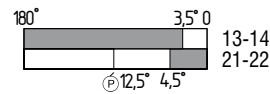

T4C 235-11Z
T4C 236-11Z

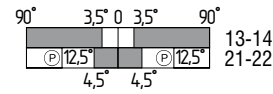

T5C 235-11Z
T5C 236-11Z

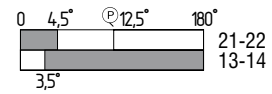

1 NC

T3C 235-01Z
T3C 236-01Z

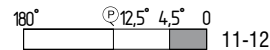

T4C 235-01Z
T4C 236-01Z

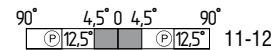

T5C 235-01Z
T5C 236-01Z

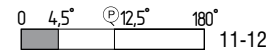

5. Set-up and maintenance

5.1 Functional testing

The safety function of the safety components must be tested. The following conditions must be previously checked and met:

1. Check the switch enclosure for damage
2. Check the free movement of the actuating element
3. Check the integrity of the cable entry and connections

5.2 Maintenance

A regular visual inspection and functional test, including the following steps, is recommended:

1. Check the free movement of the actuating element
2. Remove particles of dust and soiling
3. Check cable entry and connections

Damaged or defective components must be replaced.

6. Disassembly and disposal

6.1 Disassembly

The safety switchgear must be disassembled in a de-energised condition only.

6.2 Disposal

The safety switchgear must be disposed of in an appropriate manner in accordance with the national prescriptions and legislations.

7. Appendix

7.1 EC Declaration of conformity

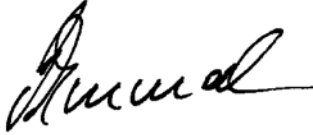
	
EC Declaration of conformity	
Translation of the original Declaration of Conformity	K.A. Schmersal GmbH & Co. KG Möddinghofe 30 42279 Wuppertal Germany Internet: www.schmersal.com
We hereby certify that the hereafter described safety components both in its basic design and construction conform to the applicable European Directives.	
Name of the safety component:	T.C 235; T.C 236
Description of the safety component:	Hinge safety switch
Relevant EC-Directives:	2006/42/EC-EC-Machinery Directive
Person authorised for the compilation of the technical documentation:	Oliver Wacker Möddinghofe 30 42279 Wuppertal
Place and date of issue:	Wuppertal, August 31, 2015
TC235-C-EN	
	Authorised signature Philip Schmersal Managing Director



The currently valid declaration of conformity can be downloaded from the internet at www.schmersal.net.



K. A. Schmersal GmbH & Co. KG
Möddinghofe 30, D - 42279 Wuppertal
Postfach 24 02 63, D - 42232 Wuppertal

Phone: +49 - (0)2 02 - 64 74 - 0
Telefax: +49 - (0)2 02 - 64 74 - 1 00
E-Mail: info@schmersal.com
Internet: <http://www.schmersal.com>